



Chimney Cooker Hood

煙囪式抽油煙機

(Model/型號 : HT-3590SG)

Installation & Operation Manual

安裝及使用說明書

Content

1.....	Safety instructions
2.....	Product Dimension
3.....	Installation
4.....	Start using your cooker hood
5.....	Troubleshooting
6.....	Maintenance and cleaning
7.....	Product Specification
8.....	Environment protection

1. SAFETY INSTRUCTIONS

This manual explains the proper installation and use of your cooker hood, please read it carefully before using even if you are familiar with the product. The manual should be kept in a safe place for future reference.

Always to do:

- ✓ Important! Always switch off the electricity supply at the mains during installation and maintenance.

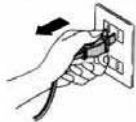

- ✓ The cooker hood must be installed in accordance with the installation instructions and all measurements followed.
- ✓ All installation work must be carried out by a qualified technician or competent person.
- ✓ Please dispose of the packing material carefully. Children are vulnerable to it.
- ✓ Pay attention to the sharp edges inside the cooker hood especially during installation and cleaning.
- ✓ When the cooker hood is located above a cooking appliance, the minimum distance between the supporting surface for the cooking vessels on the hob and the lowest part of the cooker hood that distance must be:
Gas cookers : 75 cm
Electric cookers : 65 cm
- ✓ Make sure the ducting has no bends sharper than 90 degrees as this will reduce the efficiency of the cooker hood.
- ✓ Warning! : Failure to install the screws or fixing device in accordance with these instructions may result in electrical hazards
- ✓ Warning: Before obtaining access to terminals, all supply circuits must be disconnected.

- ✓ Always put lids on pots and pans when cooking
- ✓ When in extraction mode, air in the room is being removed by the cooker hood. Please make sure that proper ventilation measures are being observed. The cooker hood removes odours from room but not steam.
- ✓ Cooker hood is for domestic use only.



- ✓ If the supply cord is damaged, it must be replaced by the manufacturer, its service agent or similarly qualified persons in order to avoid a hazard.
- ✓ Children shall not play with the cooker hood. Cleaning and user maintenance shall not be made by children without supervision.



- ✓ Caution! : The cooker hood and its accessible parts can become hot during operation. Be careful to avoid touching the heating elements. Children should stay away unless they are under permanent supervision.
- ✓ There shall be adequate ventilation of the room when the cooker hood is used at the same time as cooking appliance burning

- gas or other fuels.
- ✓ There is a fire risk if cleaning is not carried out in accordance with the instructions
- ✓ Regulations concerning the discharge of air have to be fulfilled.
- ✓ For safety reason, please use only the same size of fixing or mounting screw which are recommended in this instruction manual.
- ✓ Regarding the details about the method and frequency of cleaning, please refer to maintenance and cleaning section in the instruction manual.

Never to do:

- × Do not try to use the cooker hood without the grease filters or if the filters are excessively greasy!
- × Do not install above a cooker with a high level grill.
- × Do not leave frying pans unattended during use because overheated fats or oils might catch

fire.

- × Never leave naked flames under the cooker hood.



- × If the cooker hood is damaged, do not attempt to use.
- × CAUTION! Accessible parts may become hot when used with cooking appliance.
- × The minimum distance between the supporting surface for the cooking vessels on the hob and the lowest part of the cooker hood. (When the cooker hood is located above a cooking appliance, this distance shall be at least 65 cm)
- × The air must not be discharged into a flue that is used for exhausting fumes from cooking appliance burning gas or other fuels.

2. PRODUCT DIMENSION

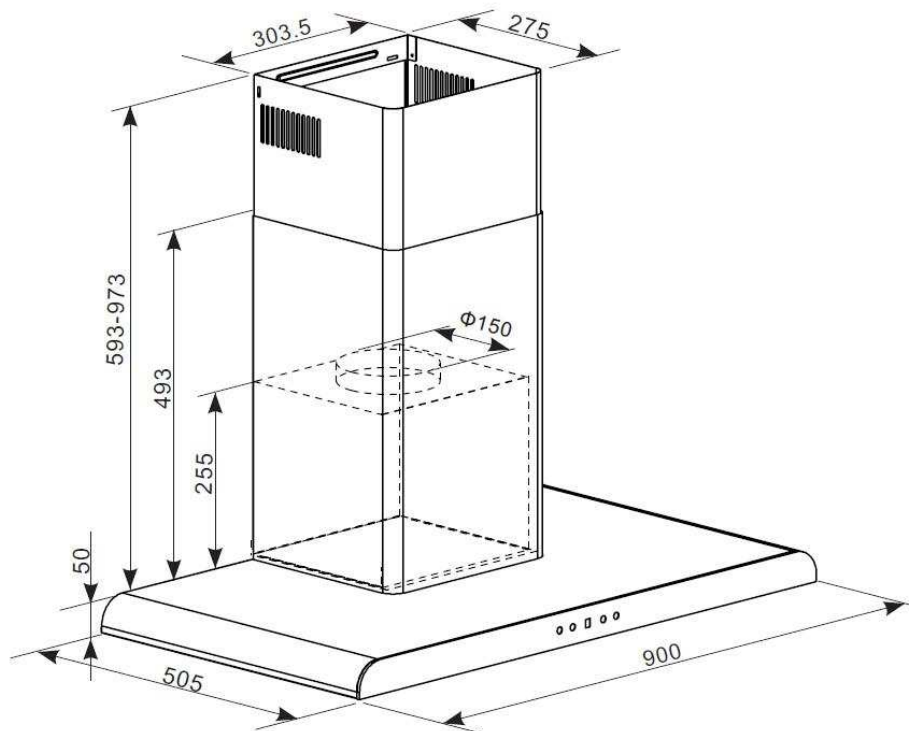

3. INSTALLATION

If you have an outlet to the outside, your cooker hood can be connected as below picture by means of an extraction duct (enamel, aluminum, flexible pipe or non-flammable material with an interior diameter of 150mm)

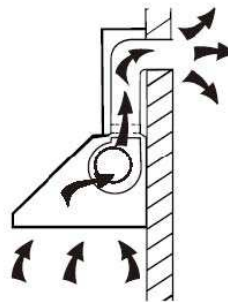

3.1 The cooker hood should be placed at a distance of 65-75cm above the cooking surface for the best effect.

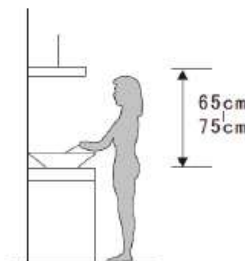

3.2 Install the hook on a suitable place once the installation height is fixed, and keep it in line. The fixed position of the inside chimney bracket is the highest place of chimney. See Pic 2.

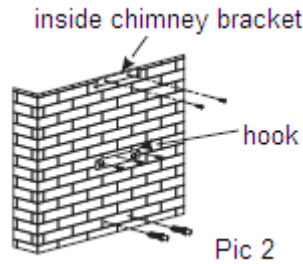

Pic 2

3.3 Lay the expansion pipe to the exhaust outlet. Fix the expansion pipe with the metal cable tie on the exhaust outlet and put the cooker hood onto the hook. See Pic 3.

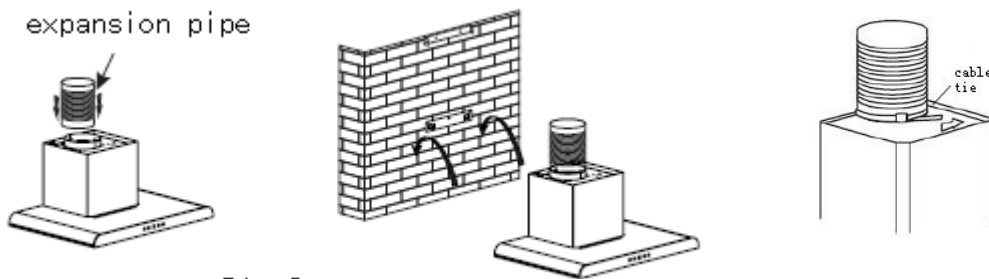

Pic 3

3.4 Fix the outside chimney bracket on the outside chimney, and be sure that the inside chimney can be adjusted the height in it freely. Put the chimney on the cooker hood and lead the expansion pipe to outside. Open the filter, fix the body with ST4*30mm safety screw. See Pic 4.

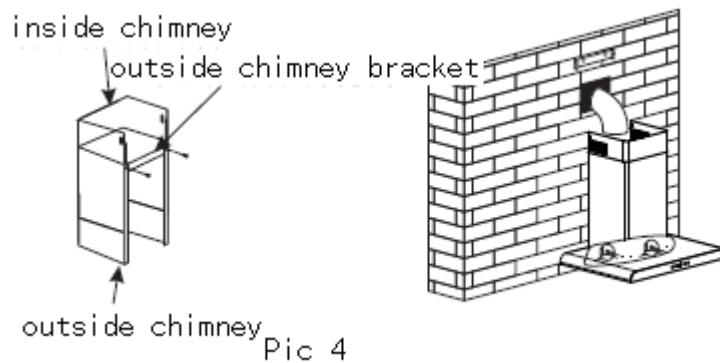

Pic 4

3.5 Adjust the height of the inside chimney to the position of the inside chimney bracket and fix on it by screw. See Pic 5.

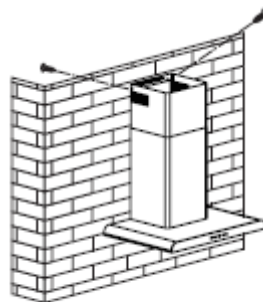



Pic 5

HINTS FOR EXHAUST DUCT INSTALLATION

The following rules must be strictly followed to obtain optimal air extraction:

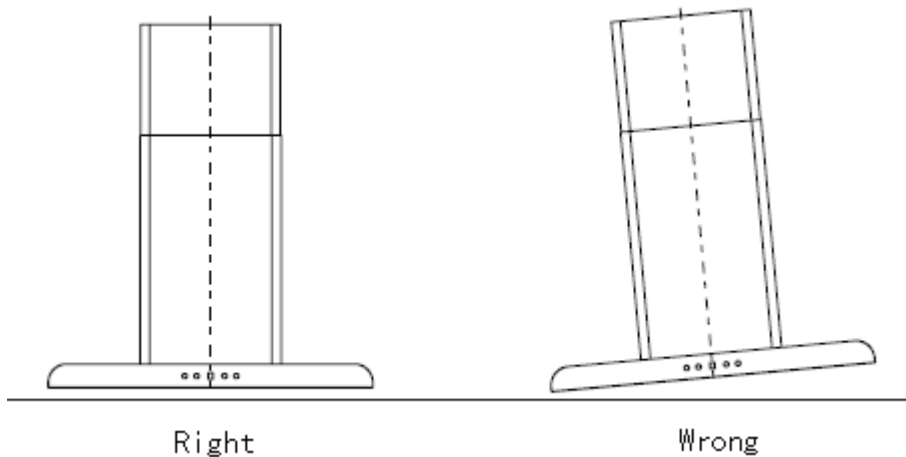
- Keep expansion pipe short and straight.
- Do not reduce the size or restrict expansion pipe.
- When using expansion pipe always install the pipe pulled taut to minimize pressure loss.
- Failure to observe these basic instructions will reduce the performance and increase noise levels of the cooker hood.
- Any installation work must be carried out by a qualified technician or competent person.
- Do not connect the ducting system of the cooker hood to any existing ventilation system which is being used for any other appliance ,such as warmer tube, gas tube , hot wind tube.
- To ensure that the the cooker hood keeps at balance and not inclined
-



<p>WARNING:</p> 	<ul style="list-style-type: none">➤ For safety reason, please use only the same size of fixing or mounting screw which are recommended in this instruction manual.➤ Failure to install the screws or fixing device in accordance with these instructions may result in electrical hazards.
-----------------------------------------------------------------------------------------------------	-------------------------------------------------------------------------------------------------------------------------------------------------------------------------------------------------------------------------------------------------------------------------------------------------------------------

4. START USING YOUR COOKER HOOD

Touch control Icons with LED display

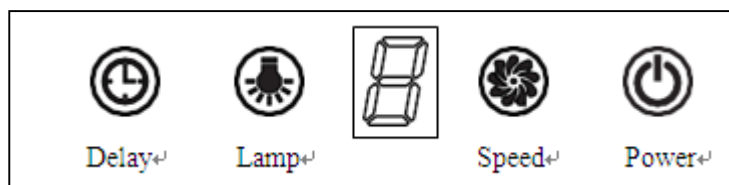

- (1) After power connection, buzzer will make a short sound and the cooker hood keeps at the stand-by mode.
- (2) Press the “Power” button, the LED will show the pre-set fan speed level 1, the fan speed will represent 1 (low) ; 2 (middle) & 3 (high) . Press the “Power” button again, the fan speed will circularly run as 1-2-3-1-2..... . When re-start the operation after stop, the fan speed will run as previous selection.
- (3) Press “Lamp” button, the light will be on, press this button again, the light will be off.
- (4) When the cooker hood is working, if press the “Delay” button, the hood will go into the status of acquiescent working (acquiescent time is 9 mins). When time is reached, the cooker hood will stop operation.

5.TROUBLESHOOTING

Fault	Possible Cause	Solution
Light on, but motor does not work	Fan switch turned off	Select a fan switch position.
	Fan switch failed	Contact your local agent.
	Motor failed	Contact your local agent.
Light does not work, motor does not work	House fuses blown	Replace fuses.
	Power cord loose or disconnected	Refit cord to power outlet. Switch power outlet on.
Oil leakage	Leakage from the oil cup	Refer to maintenance and cleaning section to clean the old cup
	Leakage from the mesh filter	Refer to maintenance and cleaning section to clean the mesh filter
Lights not working	Broken/Faulty globes	Contact your local agent.
Insufficient suction	The distance between the cooker hood and the gas top is too far	Refit the cooker hood to the correct distance.
The cooker hood inclines	The fixing screw not tight enough	Tighten the hanging screw and make it horizontal.

NOTE:



Any electrical repairs to this appliance must conform to your local, state and federal laws. Please contact the service centre if in any doubt before undertaking any of the above. Always disconnect the unit from the power source when opening the unit.

6. MAINTENANCE AND CLEANING

Caution:

- Before maintenance or cleaning is carried out, the cooker hood should be disconnected from the main power supply. Ensure that the cooker hood is switched off at the wall socket and the plug removed.



- External surfaces are susceptible to scratches and abrasions, so please follow the cleaning instructions to ensure the best possible result is achieved without damage.

GENERAL

Cleaning and maintenance should be carried out with the cooker hood cold especially when cleaning. Avoid leaving alkaline or acid substances (lemon juice, vinegar etc.) on the surfaces.

● STAINLESS STEEL

The stainless steel must be cleaned regularly (e.g. weekly) to ensure long life expectancy. Dry with a clean soft cloth. A specialized stainless steel cleaning fluid may be used.

● CONTROL PANEL SURFACE

The inlay control panel can be cleaned using warm soapy water. Ensure the cloth is clean and well wrung before cleaning. Use a dry soft cloth to remove any excess moisture left after cleaning.

Important:

Using neutral detergents and avoid using harsh cleaning chemicals, strong household detergents or products containing abrasives, as this will affect the cooker hood appearance and potentially remove any printing of artwork on the control panel and will void manufacturer's warranty.

● GREASE MESH FILTERS

Pls. refer and follow the below cleaning methods for the mesh filters:

- 1) The mesh filters can be cleaned by

hand. Soak them for about 2-3 minute in water with a grease-loosening detergent then brush it gently with a soft brush. Please do not apply too much pressure, avoid to damage it .

- 2) Wash with a dishwasher. Put the mesh filters into the dishwasher, add the suitable amount of mild neutral cleaners, and adjust the temperature to 60°C washing.

DISMANTLING & INSTALLING GREASE MESH FILTERS

- Angle the filter into slots at the back of the hood.
- Push the button on handle of the filter.
- Release the handle once the filter fits into a resting position.
- Repeat to install all filters.

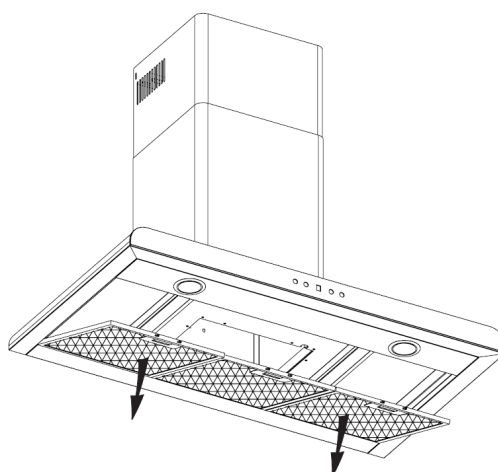

● CARBON FILTER- (Optional item)

Activated carbon filter can be used to trap odors. Normally the activated

carbon filter should be changed at three or six months according to your cooking habit. The installation procedure of activated carbon filter is as below.

1. Before installing or replacing the carbon filters, please remove power to the unit.
2. Press the filter lock and remove the mesh filter.

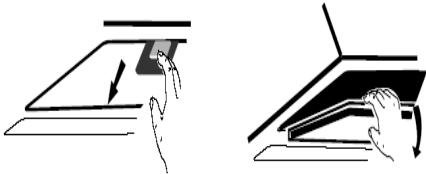

3. Turn the carbon filter on both side of the motor anti-clockwise. Replace the carbon filters with the new carbon filters.

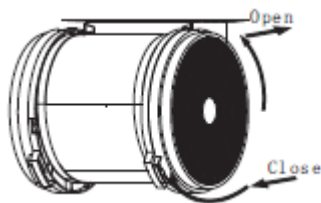

4. Place the mesh filter.
5. Connect the power supply to the wall socket.

NOTE:

- Make sure the filter is securely locked. Otherwise, it would loosen

and cause dangerous.

- When activated carbon filter attached, the suction power will be lowered.

● **THE OIL CUP**

- Your cooker hood includes a unique oil cup which collects the oil that is deposited on the grease filters.
- When the oil cup is about 2/3 full the oil cup needs to be cleaned.
- Take away the oil cup as the diagram below shows, by pushing the oil cup upwards and then pulling forwards to release it from the Cooker hood.

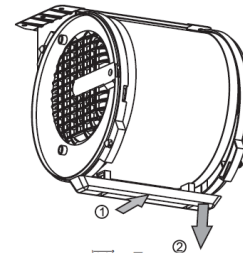

7.PRODUCT SPECIFICATION

Model No.	HT-3590SG
Rated voltage	220 ~ 240V 50Hz
Lamp power	1.5W LED ×1
Motor power	380W
Expansion pipe diameter	Φ150mm
Airflow	1000m ³ /h
Net weight	13kgs

8.ENVIRONMENTAL PROTECTION:

	<p>This product is marked with the symbol on the selective sorting of waste electronic equipment. This means that this product must not be disposed of with household waste but must be supported by a system of selective collection in accordance with Directive 2012/19/EU. It will then be recycled or dismantled to minimize impacts on the environment, electrical and electronic products are potentially dangerous for the environment and human health due to the presence of hazardous substances. For more information, please contact your local or regional authorities.</p>
------------------------------------------------------------------------------------	-------------------------------------------------------------------------------------------------------------------------------------------------------------------------------------------------------------------------------------------------------------------------------------------------------------------------------------------------------------------------------------------------------------------------------------------------------------------------------------------------------------------------------------------------------------------------------------------

NOTE! :

The following shows how to reduce total environmental impact (e.g. energy use) of the cooking process).

- (1) Install the cooker hood in a proper place where there is efficient ventilation.
- (2) Clean the cooker hood regularly so as not to block the airway.
- (3) Remember to switch off the cooker hood after cooking.

目錄

一.....	安全指引
二.....	產品尺寸
三.....	安裝說明
四.....	產品操作說明
五.....	維修指南
六.....	日常保養及清潔
七.....	產品規格
八.....	環境保護

一、安全指引

此說明書詳細列明產品的適當安裝及操作方法，請於安裝及操作抽油煙機之前閱讀本說明書及妥善保存作日後參考。

經常要做:

- ✓ **重要！**於安裝或維修抽油煙機時，應先關掉電源及拔掉電源插頭。

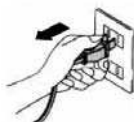

- ✓ 抽油煙機必須按照安裝說明書上的安裝指引，並遵循提供之資料數據。
- ✓ 所有安裝及維修工序應由合資格技工進行。
- ✓ 請小心處理包裝材料，避免兒童容易接觸產生意外。
- ✓ 在安裝和清潔過程中，注意抽油煙機內的鋒利邊緣，以免受傷。
- ✓ 抽油煙機最底位置與爐具的支撐架之間距離最少為：
氣體煮食爐：75 厘米
電煮食爐：65 厘米
- ✓ 確保管道沒有彎曲超過 90 度，因為這將會影響抽油煙機的排風效果。
- ✓ **警告！**：不按照說明書安裝螺釘或固定裝置可能會導致電氣危險
- ✓ 在煮食過程中，煮食器皿都必須將蓋子蓋上。
- ✓ 在正常排風模式下，房間內的空氣將會被抽油煙機移除。請確保遵從適當的通風措施。抽油煙機去除房間裡的氣味，但不能去除蒸汽。
- ✓ 抽油煙機僅供家居使用。



- ✓ 如電源線損壞，必須由製造商、其服務代理或合資格人仕更換，以避免觸電危險。

- ✓ 兒童或缺乏經驗和知識人仕進行使用抽油煙機或進行清潔，都必須得到成年人的監督或指導，以免產生意外。



- ✓ **注意！**：在操作抽油煙機過程中，抽油煙機有部份位置可能接觸時感覺熱力。兒童必須遠離抽油煙機，除非得到成年人的監督或指導。
- ✓ 當使用抽油煙機抽取煮食時產生的油煙，室內必須保持足夠排風空間。
- ✓ 抽油煙機應按照說明書上指引定期清潔，以避免火災風險。
- ✓ 必須遵守有關排放空氣的規定。
- ✓ 為了安全起見，請使用本說明書內建議相同尺寸的固定或安裝螺釘進行安裝。
- ✓ 有關清洗方法和頻率的詳細資訊，請參閱說明書內的"日常保養及清潔"一節。

從不要做:

- × 切勿使用沒有蓋上過濾網或沾上油膩的過濾網操作抽油煙機。
- × 切勿安裝抽油煙機與爐具距離過高。
- × 不要在無人看管下使用煎鍋，因為過熱的油脂可能會引起火種。
- × 切勿在抽油煙機下方進行明火干燒操作。



- × 抽油煙機如有損壞，不應繼續使用。
- × **警告！**：當煮食過程中，抽油煙機有部份位置可能接觸時感覺熱力。

- × 抽油煙機最底位置與爐具的支撐架之間距離最少為 65 厘米。
- × 煙道只適用於排出經爐具燃燒所產生的煙霧。

二、產品尺寸

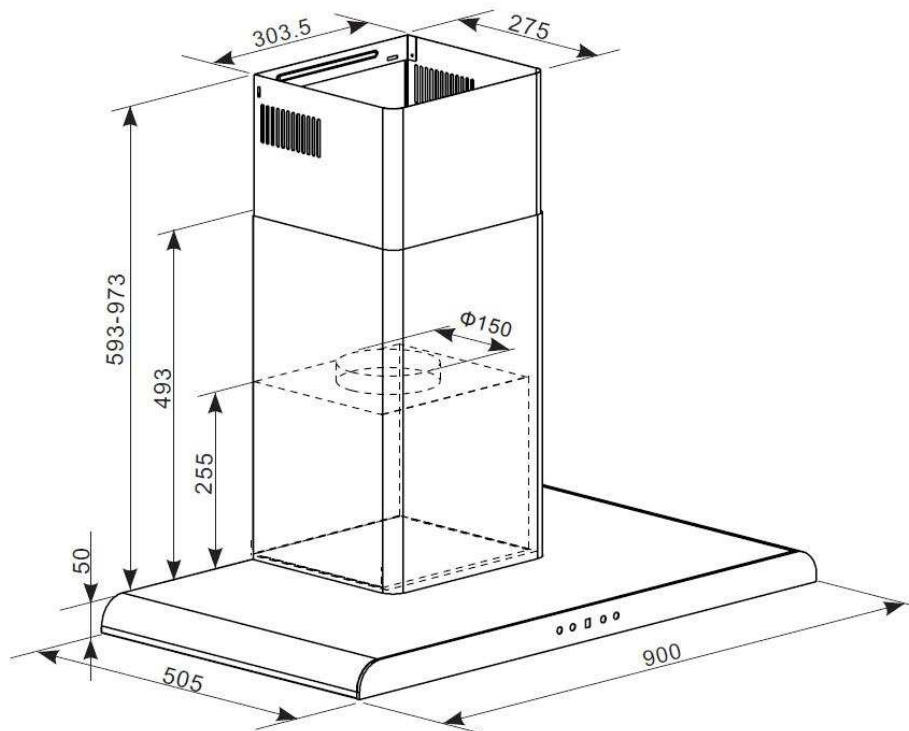

三、安裝說明

如你的抽油煙機需由室內接駁至室外，你必須按照下列圖示使用一條排氣管連接你的抽油煙機排風口接駁至室外，排氣管應使用鋁質；軟管或不易燃的材料，內部直徑為 150 毫米。

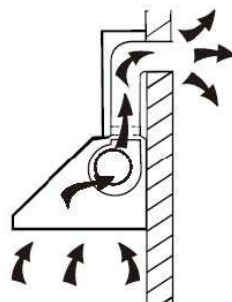

3.1. 抽油煙機底部與爐具之間距離最少為 65-75 厘米，以保持最佳吸油煙效果。

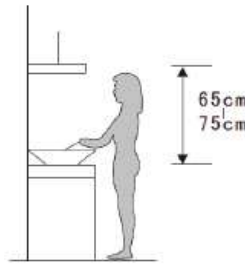

3.2 固定安裝高度後，將掛鉤(hook)安裝在合適的位置並保持水平線。內煙囪支架(inside chimney bracket)的固定位置是煙囪的最高位置。請參見圖 2 (Pic 2)。

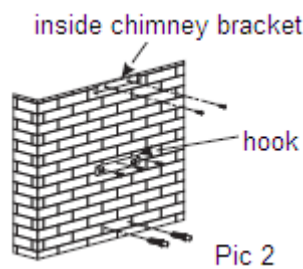

3.3 將排氣管(expansion pipe)套上抽油煙機的排氣口及用鑼絲批將隨附的金屬圈(cable tie)收緊。然後將抽油煙機放在鉤子上。請參見圖 3 (Pic 3)。

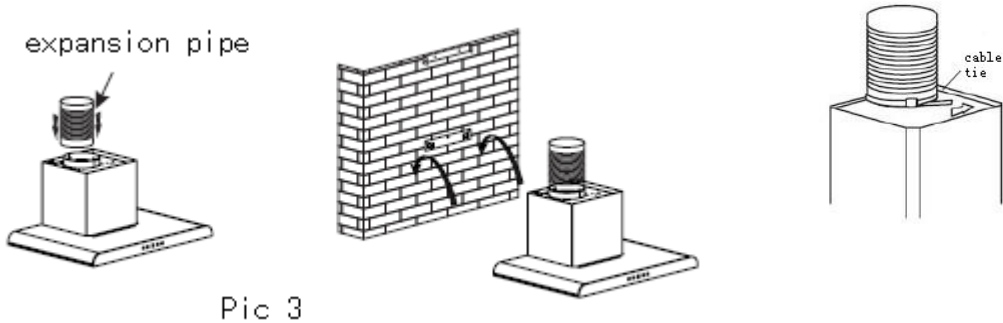

3.4 將外部煙囪支架(outside chimney bracket)固定在外煙囪(outside chimney)上，確保內煙囪(inside chimney)可以自由調節其高度。然後把煙囪放在抽油煙機上，把排氣管引向室外。打開金屬過濾網，用 ST4*30mm 安全螺絲固定身體。請參見圖 4(Pic 4)

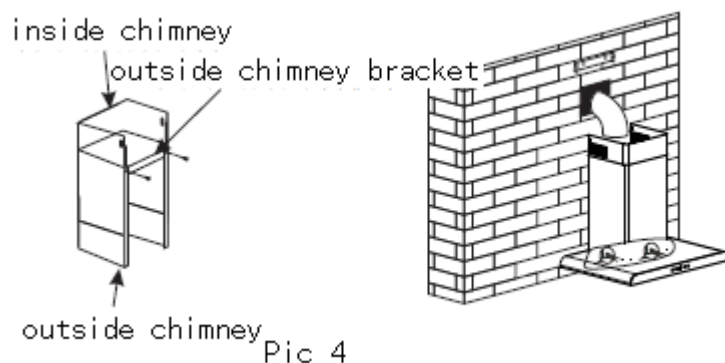

3.5 將內部煙囪的高度調整到煙囪支架內的位置，並用螺絲固定在其上。請參見圖 5 (pic.5)。

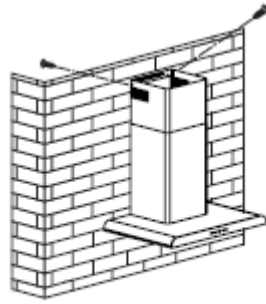



Pic 5

安裝排氣管提示

必須嚴格遵守以下規則才能獲得最佳的排風效果：

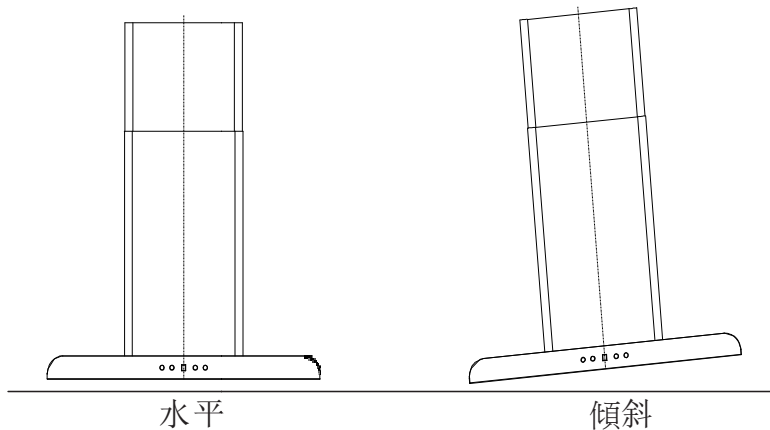
- 保持排氣管短而直。
- 不可減小排氣管的尺寸或限制排氣管。
- 使用排氣管時，應將管拉緊，減少排風壓力損失。
- 不遵從基本安裝說明，或有機會降低抽油煙機的功能性或引致噪音水準。
- 所有安裝工序應由合資格技工進行。
- 不要將排氣管連接到任何現有的通風系統或其他設備，如暖管、燃氣管、熱風管等。
- 要確保抽油煙機保持水平及不可傾斜。



<p>警告</p> 	<ul style="list-style-type: none">➤ 為了安全起見，請使用本說明書中建議的相同尺寸的固定或安裝螺釘。➤ 未按照說明書上安裝螺釘或固定裝置可能會導致電氣危險。
------------------------------------------------------------------------------------------------------	------------------------------------------------------------------------------------------------------------------------

四、產品操作說明

觸控圖示及數位顯示

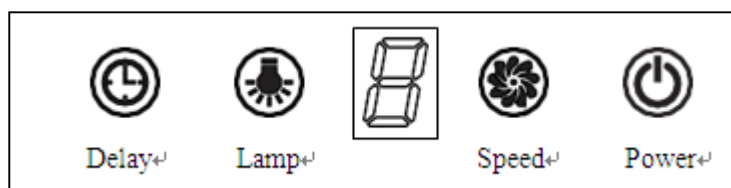

- (1) 按“Power”圖示，蜂鳴器會發出一短聲，表示電源已接通，抽油煙機處於待機狀態。
- (2) 按“Speed”圖示，LED 數碼顯示預設風速段數為 1，風速段數分別為 1(低風速); 2(中風速) 及 3(高風速)。再按“Speed”圖示，風速段數將會循環地改變風速段數如 1-2-3-1-2……。停止運作後，再重新開啟，風速段數將顯示之前使用的風速段數。
- (3) 按“Lamp”圖示，LED 將會亮著。再按“Lamp”圖示，LED 將會熄滅。
- (4) 當抽油煙機運作中，可按延遲關機“Delay”圖示，抽油煙機將會在 9 分鐘後停止工作及關機。

五、維修指南

現象	可能原因	解決方式
LED 燈亮著，但電機不動	沒有啟動風速	啟動風速檔
	開關有問題	聯絡當地代理商
	電機有問題	聯絡當地代理商
LED 燈不亮及電機不動	檢查是否保險絲失效	更換保險絲
	電源線是否鬆脫或電源線是否未有接駁電源	檢查電源線有否鬆脫或有否接駁電源
漏油	檢查油杯是否溢滿	參照"日常保養及清潔"一節中的指引, 清潔你的油杯。
	檢查過慮網是否沾滿油污	參照"日常保養及清潔"一節中的指引, 清潔你的過慮網。
LED 燈不亮	LED 燈失效	聯絡當地代理商
吸力不強	檢查抽油煙機底部與爐具之間距離是否太遠	重新固定油煙機底部與爐具之間距離
抽油煙機震動	檢查抽油煙機鑼絲是否已上緊	重新上緊抽油煙機鑼絲



注意:

抽油煙機的任何維修都必須符合當地法律。如有任何疑問，請向當地代理商聯繫及查詢。如有任何上述疑問，請務必同時關掉產品與電源之連接。

六、日常保養及清潔

警告！：

- 在進行維護或清潔之前，應將抽油煙機先關掉電源及拔掉電源插頭，以確保安全。
- 抽油煙機外部表面容易被劃傷和擦傷，因此請按照清潔說明操作，以確保在不損壞的情況下實現最佳效果。

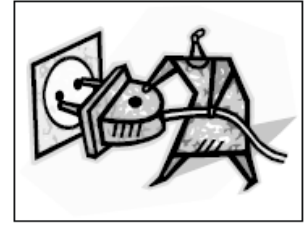

概括

一般清潔和維護應在抽油煙機冷卻下進行。特別是在清潔時，避免在表面留下鹼性或酸性物質 (檸檬汁、醋等)。

● 不銹鋼表面

必須定期清潔不銹鋼表面 (如每星期進行一次)，以確保延長產品的使用壽命。用乾淨的軟濕布擦乾或使用專用不銹鋼清洗液。

● 控制面板表面

控制面板表面可使用溫熱肥皂水清洗 (清潔前確保布料清潔)，然後使用乾軟布去除清潔後留下的多餘水分。

重要事項：

清潔時，應使用溫和中性清潔劑及避免使用苛刻的清潔化學品，強力家用清潔劑或含有磨料的清潔產品。因為這將影響產品外觀，並有可能消除控制面板上的絲印圖案，而且會影響日後的保養服務。

● 金屬過濾網

抽油煙機的過濾網為金屬制品，請不要使用對金屬制品帶有腐蝕性的清潔劑進行清洗。

請參考及按照下列清洗方法：

- 1) 將金屬過濾網浸在 40-50°C 熱水中，並放適量溫和中性清潔劑，浸約 2 至 3 分鐘。然後，戴上手套用軟毛刷輕輕刷過過濾網，切勿用力過度，以免損壞過濾網。
- 2) 用洗碗碟機清洗。將金屬過濾網放入洗碗碟機，加入適量溫和中性清潔劑，將溫度調至 60°C 洗滌。

拆卸及安裝金屬過濾網簡單步驟：

- 1) 將金屬過濾網把手向後方拉，取出金屬過濾網
- 2) 將金屬過濾網放回原位，需將金屬過濾網後方扣位相應地先插回機體，然後將金屬過濾網把手向後方拉，將金屬過濾網前方扣位相應地插回機體

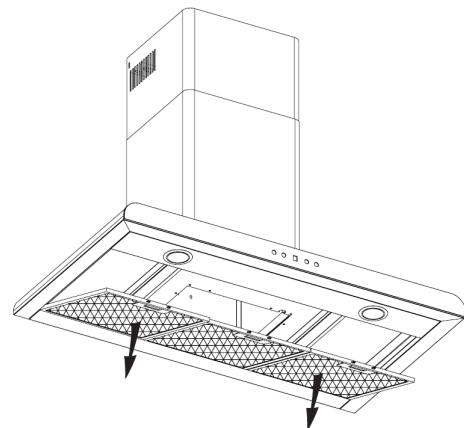

● 活性炭過濾網-(選擇性選配)

活性炭過濾網適用於過濾煮食油煙氣味，

保持廚房空氣清新。一般情況下, 活性炭過濾網根據你的烹飪習慣在三至六個月內更換。

拆卸及安裝活性炭過濾網簡單步驟：

1. 為安全起見, 先將電源關掉
2. 將金屬過濾網把手向後方拉, 取出金屬過濾網

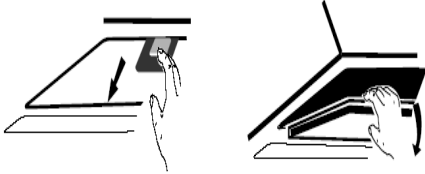

3. 按照下列圖示將活性炭過濾網在馬達兩邊扣位正確對位, 然後按照正確方向擰緊

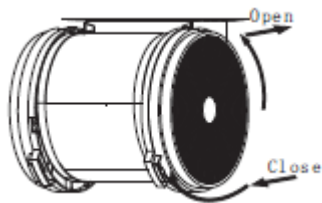

4. 將金屬過濾網放回原位, 需將金屬過濾網後方扣位相應地先插回機體, 然後將金屬過濾網把手向後方拉, 將金屬過濾網前方扣位相應地插回機體

5. 重新啟動電源

注意！:

- 確保活性炭過濾網安全鎖定, 避免鬆脫, 否則造成危險
- 安裝活性炭過濾網可能會令排風減弱

● 集油杯

- 抽油煙機內馬達底部有一個獨特的集油杯, 作用是收集油沉積的油脂(將金屬過濾網拆卸後可見)
- 當集油杯約滿三分之二時, 就需拆卸進行清洗
- 如下列圖示, 將集油杯向上推, 然後向前拉, 將其取出

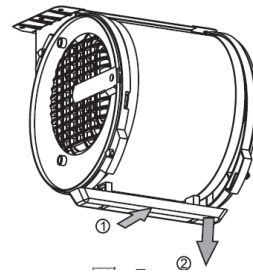

七、產品規格

型號	HT-3590SG
適用電源	220 ~ 240V 50Hz
照明(瓦)	1.5W LED×1
馬達耗電量(瓦)	385W
排風口直徑(毫米)	Φ150mm
最高排風量(每小時立方米)	1000M ³ /h
淨重量(千克)	13

八、環境保護:

	<p>抽油煙機標有廢棄電子設備選擇性分類的符號。這意味著, 這類型產品不得與生活垃圾一起處置, 而必須根據指令2012/19/EU得到選擇性收集制度的支援。然後, 將對其進行回收或部件拆除, 以儘量減少對環境造成的影響, 電氣和電子產品因存在危害物質而對環境和人類健康構成潛在危害。欲瞭解更多資訊, 可聯絡你的當地回收廢置供應商。</p>
-----------------------------------------------------------------------------------	---------------------------------------------------------------------------------------------------------------------------------------------------------------------------

注意!:

下面介紹了如何減少烹飪過程對環境的總體影響 (例如能源使用)。

- (1) 將抽油煙機安裝在通風效率較高的適當位置。
- (2) 定期清潔抽油煙機, 以免堵塞氣道。
- (3) 烹飪後記得關掉抽油煙機。

Sole Agent : Araytron Technology Limited
總代理 : 千中科技有限公司
Service Hotline/服務熱線 : +852 2397 3066
Fax/傳真 : +852 2397 3055
Website/網址 : www.garwoods.com.hk